











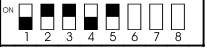
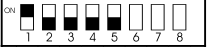
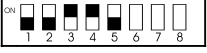
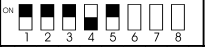
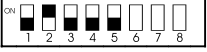
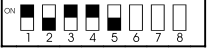
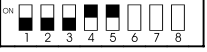
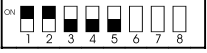
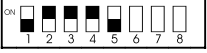
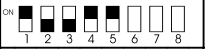
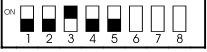
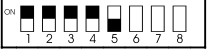
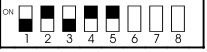













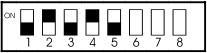

# HT88 Timer Module (1sec - 10hr)

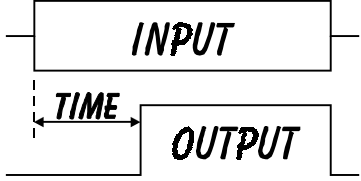
DIP Switch	Time	DIP Switch	Time	DIP Switch	Time
	1s		45s		25m
	1.5s		1m		30m
	2s		1.5m		45m
	3s		2m		1hr
	4s		3m		1.5hr
	5s		4m		2hr
	8s		5m		3hr
	10s		8m		5hr
	15s		10m		8hr
	20s		15m		10hr
	30s		20m		

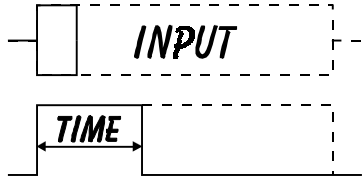
	<b>Delayed Output</b> 		<b>Minimum Period</b> 
	<b>Momentary Trigger</b> 		<b>Extends Input Period</b> 

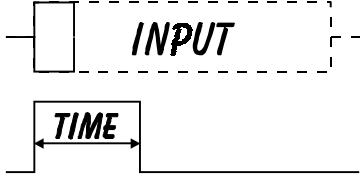
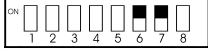
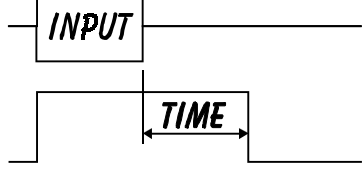
DIP Switch	Input type
	Normally Open (Close TRIG contacts to activate)
	Normally Closed (Open TRIG contacts to activate)

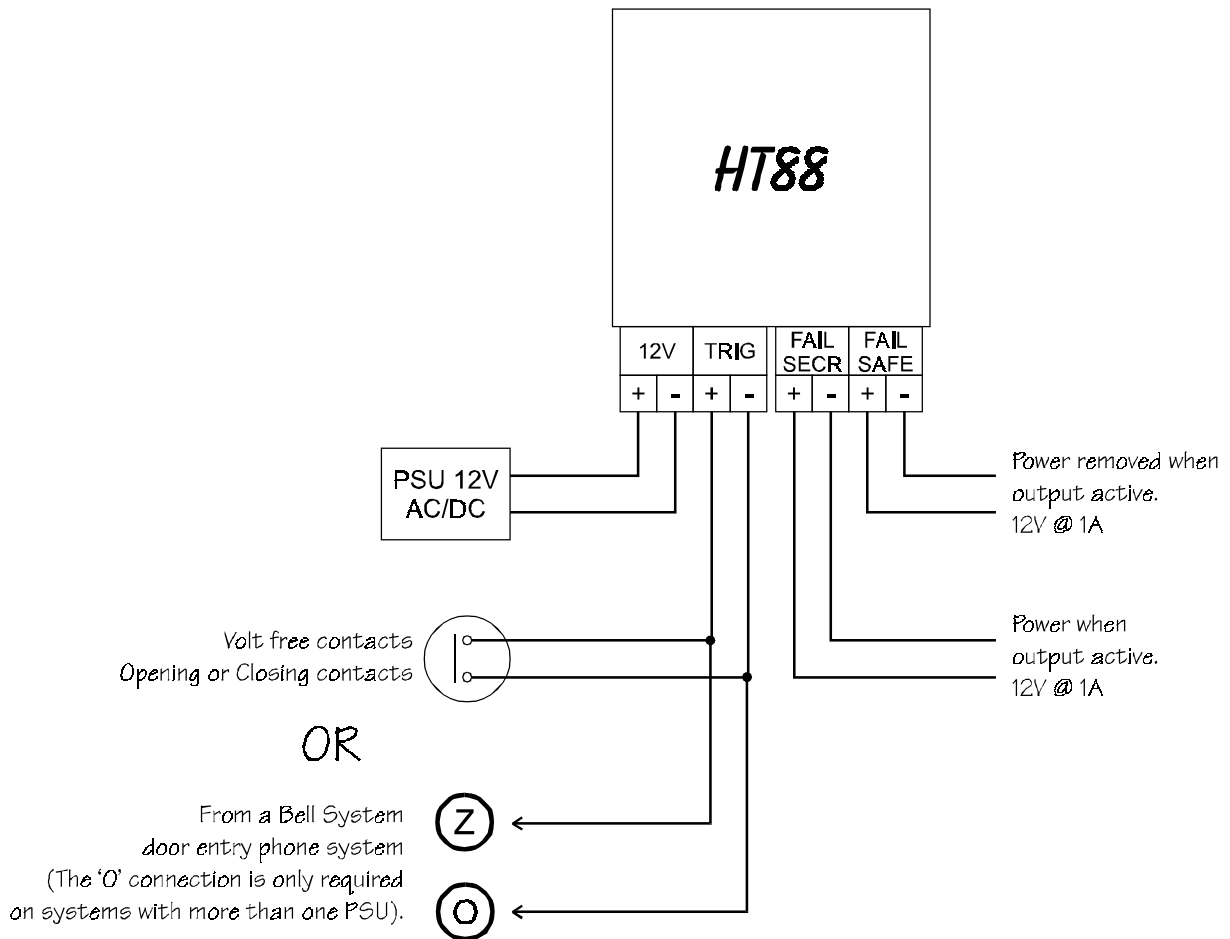

## Electrical Specification

### Inputs

Supply - 10V - 14V AC or DC at 70mA.

Trigger - Volt free closing or opening contact.

### Outputs

As input (max current 1A)

## HT88 Test Button Operation

Pressing the test button forces the output to ON regardless of the TRIG input or DIP switch settings.

## HT88 LED Operation

The LED flashes 3 times (1 second) when power is applied to the HT88.

When the output is ON the LED will be ON, if the TRIG input is active and the output is off (e.g. delayed output mode) the LED will flash (½ second).